

# Limited Warranty

## SUPREME HYBRID X MASSAGE LOUNGER

### Consumer Limited Warranty: ONE-YEAR WARRANTY

This warranty guarantees that the product purchased is to be free from defects in material and workmanship under normal usage and local voltage for a period of one year. This warranty expires in **TWO (2) years on parts, and ONE (1) year on labor** after the date of purchase.

U.S. JACLEAN, INC. (referred to as "the Warrantor") will repair this product with new or rebuilt parts in case of defects in material or workmanship, free of charge, in the USA provided that:

- 1) The product is operated in accordance with the printed instructions supplied.
- 2) The product is used under normal conditions for which designed.
- 3) The product is not subjected to misuse, negligence, or accident.
- 4) The product receives proper care, protection, and maintenance.

This warranty is extended to the original end-user when purchased from an authorized U.S. JACLEAN, INC. distributor. A purchase receipt or other proof of date of the original purchase is required for service and parts replacement under this warranty. This warranty does not cover shipping charges for defective items if a claim is made more than 30 days after the date of purchase.

This warranty only covers failures due to defects in materials and workmanship and does not cover normal wear or cosmetic damages. This warranty does not cover damages which occur in shipment, or failures which result from: accident, misuse (including, without limitation, failure to comply with instructions and use limitations contained in the Operating Instructions), abuse, neglect, mishandling, faulty installation, set-up adjustments, improper operation or maintenance, alteration, modification, a power line surge, lightening, improper line voltage, commercial use (e.g., as a service in a hotel, office, restaurant, or other business or for rental use), service by anyone other than from U.S. JACLEAN, INC., or damage that is attributable to "acts of God." Continued use of this product after discovering a defect voids this warranty. This warranty shall be governed by the state of California, United States of America.

**IMPORTANT: CONTACT U.S. JACLEAN, INC. FOR REPAIR SERVICES.  
DO NOT RETURN A DEFECTIVE PRODUCT TO THE STORE FROM  
WHICH YOU PURCHASED IT.**

Please retain this Warranty Certificate, together with the original purchase receipt, and present it to our technician for inspection during service.

For assistance and more information, please contact U.S. JACLEAN, INC.

Online warranty registration at: [daiwamassage.com/warranty](http://daiwamassage.com/warranty)

Daiwa x ROTAI

**SUPREME X**  
HYBRID  
MASSAGE LOUNGER

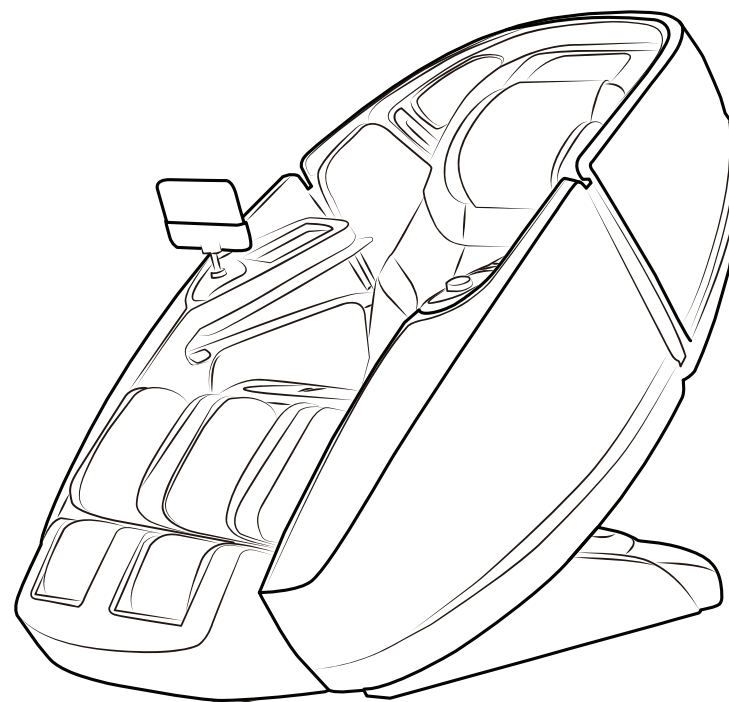

OPERATING INSTRUCTIONS

SPH-X

**Daiwa**  
FELICITY

Distributed by U.S. Jaclean, Inc.  
Gardena, CA 90249

**1-800-241-2221**  
9AM - 5PM PST (Monday - Friday)

[daiwamassage.com](http://daiwamassage.com)

## ▶ **SUPREME HYBRID X MASSAGE LOUNGER**

---

Thank you for purchasing the **Supreme Hybrid X**.

Before using this chair for the first time, please read through all sections of this user manual carefully, paying special attention to the Safety Instructions.

PLEASE RETAIN THIS MANUAL FOR FUTURE REFERENCE.

## ▶ **CONTENTS**

---

IMPORTANT SAFETY PRECAUTIONS.....	1
SPECIAL FEATURES .....	4
PARTS .....	6
Exterior Structure .....	6
Interior Structure .....	6
Armrest Controller .....	7
MESSAGE CHAIR OPERATION .....	8
Armrest Controller Operation .....	8
Display Screen Operation .....	9
Voice Command .....	10
SETUP .....	13
Massage Chair Placement .....	13
Installation .....	14
Initial Operation .....	18
Move Method .....	19
Grounding Instruction .....	20
PRODUCT STORAGE AND MAINTENANCE .....	21
TROUBLESHOOTING.....	22
TECHNICAL SPECIFICATIONS.....	23

## ▶ IMPORTANT SAFETY PRECAUTIONS

Please pay close attention to the following safety information while using your massage chair. Please carefully read all instructions before using this product.

### WARNING





In order to reduce risk of fire, burns, electric shock or injury to others, please abide by the following instructions:

1. Be sure to unplug the unit when it is unattended. Ensure that it is left unplugged when not in use or before installing or removing any parts.
2. Children and any person requiring special care should use this unit under adult supervision.
3. Be sure to use this unit for the purposes described in this manual. Please do not install parts and accessories not provided by the manufacturer.
4. This unit must not be used under these conditions:
  - a) the power cord or plug is damaged.
  - b) the unit is malfunctioning or operating incorrectly.
  - c) the unit is damaged or exposed to water.
 Contact our service center for inspection and repair.
5. Do not move this massage chair by pulling the power cord or using the cord as a handle.
6. Be sure to keep the power cord away from any source of heat.
7. Do not use this unit when the air outlet is blocked. Please keep the air outlet unblocked and free from hair and dust.
8. Do not drop or insert any objects into any opening.
9. Do not use this product outdoors.
10. Do not use this product in areas where aerosol products are used or oxygen is being released.
11. To power off, please switch off all controls before unplugging.
12. Please do not stand on or in the unit. It can only be used in a seated position.
13. Be sure to supervise children and ensure that they do not use the unit as a toy or for playing.
14. Connect this unit to a properly grounded outlet only. See Grounding Instructions (Page 20).
15. This unit is not intended for use by persons (including children) with reduced sensory or mental capabilities, or those with a lack of experience or knowledge of its operation, unless they have been given supervision or instruction concerning use of the appliance by a person responsible for their safety. Children should be supervised to ensure that they do not play with the unit.
16. If the covering is torn or worn away, do not use the unit and return to service center for replacement of outer cover.

**SAVE THESE INSTRUCTIONS**

## ▶ IMPORTANT SAFETY PRECAUTIONS

**Read all warnings carefully before use.** Precautions and warnings listed below will help to ensure proper use of this appliance. The classes of accidents caused by incorrect use are classified into “WARNING” and “CAUTION.” Strict safety prohibitions are marked with the “Prohibited” symbol. Warnings against taking components apart are marked with a “No Disassembly” symbol. Prior to use, please read all such statements below and follow all instructions within this manual.

 <b>WARNING</b>	Improper use may cause injury to users.
 <b>CAUTION</b>	Improper use may cause injury to users or product damage.
 Prohibited	 Do Not Disassemble

### Not Suitable for the Persons Below

Those with any of the following conditions should consult their physician before using.

 <b>WARNING</b>	<ul style="list-style-type: none"> <li>• Those who are using an electronic medical instrument embedded in the body, such as a cardiac pacemaker.</li> <li>• Those undergoing treatment, especially those who are not feeling well.</li> <li>• Those with malignant tumors or malignant skin conditions.</li> <li>• Women who are pregnant.</li> <li>• Those with osteoporosis or spinal fractures.</li> <li>• Those with a skin disease or those whose skin is injured.</li> <li>• Those with a high fever.</li> <li>• Close supervision is necessary when this product is used by, on, or near children, those with limited capacities or limited movement, and disabled persons.</li> </ul>
--	---

### Controller Precautions

 <b>CAUTION</b>	<ul style="list-style-type: none"> <li>• Do not operate the controller with damp hands. Do not spill water or other liquid onto the controller and do not expose it to excessive humidity in order to avoid it from shorting or experiencing malfunction.</li> <li>• Do not place heavy objects on top the controller, as damage may occur.</li> </ul>
--	--

### AC Adapter and AC Cord Precautions

**Very important: check that the power voltage stated on the rating label corresponds to your local electrical supply.**





 <b>CAUTION</b>	<ul style="list-style-type: none"> <li>• Do not use damp hands to unplug the AC cord in order to avoid electric shock.</li> <li>• To avoid damage to the cord, do not pull on the AC cord itself; instead grab the head of the plug and pull straight out to unplug it.</li> <li>• Do not crush the AC cord with the appliance or other heavy object.</li> <li>• Do not damage, over-bend, yank, twist, or tie the power cord. If the power cord is damaged, DO NOT USE. It must be replaced by the manufacturer or an appointed service agent before further use.</li> </ul>
--	---

## ▶ IMPORTANT SAFETY PRECAUTIONS

### Usage Environment

 <b>CAUTION</b>	<ul style="list-style-type: none"> <li>Do not use this appliance in environments where temperature is over 40°C/104°F.</li> <li>Ensure chair is placed on a flat, level floor prior to use.</li> <li>Do not use this appliance in an excessively humid or dusty environment, or when any part of the body is in contact with water.</li> <li>Keep the air openings free of lint, hair, and dust. Check clearance of passages regularly or when you experience a reduction in performance.</li> <li>Unplug entire chair from the outlet during thunder or lightning storms, and before putting on or taking off parts.</li> <li>Do not use outdoors.</li> <li>Do not store near heat or open flame. Avoid excessive sunlight.</li> </ul>
---	---

### Best Practices For Safe Use

 <b>CAUTION</b>	<ul style="list-style-type: none"> <li>Intended only for users below 300lbs (136 kg).</li> <li>Use this product only for its intended use as described in this manual.</li> <li>Do not use the product for therapeutic treatment purpose. This product is not intended as a replacement for treatment by a qualified, trained medical professional.</li> <li>Chair should only be used by one person—do not use with two or more persons at the same time to avoid damage to the product.</li> <li>Do not use the product right after a meal, as it may cause discomfort.</li> <li>Prior to use, remove jewelry and accessories from the arms, neck, and hands, and empty pockets.</li> <li>Check the upholstery and under the cushions and other spots, and if any damage is present discontinue use and contact the manufacturer for servicing.</li> <li>If you feel any abnormal discomfort during the operation of this product, turn off the power immediately and do not use further. Consult your doctor before resuming use.</li> <li>Limiting use of the massage chair for 20 minutes at a time is highly recommended.</li> <li>Make sure there are no obstructions behind the chair and that there is sufficient clearance before adjusting the backrest or legrest angle. Look out for pets or children when raising or lowering the chair.</li> <li>Make sure that no extra weight or pressure is pressing down on the backrest or legrest apart from the user.</li> <li>Make sure there are no children, pets or other objects under the backrest or legrest.</li> <li>Please stay properly seated while using the appliance.</li> <li>Do not drag or push the chair or caster across wood floor or carpet to avoid damage.</li> </ul>
 <b>PROHIBITED</b>	<ul style="list-style-type: none"> <li>Never operate this chair if it has been damaged or if it has exposed parts or shows signs of power leakage.</li> <li>Do not stand on or stack heavy objects on the legrest, armrests, or backrest.</li> <li>Children should be supervised to ensure that they do not play with the massage chair.</li> <li>Do not fall asleep while the chair is operating.</li> <li>Avoid using the chair under the influence of alcohol or sedatives.</li> <li>Do not put hands or fingers in any openings of the chair to avoid injury to self or damage to the chair.</li> <li>If there is any smoke or an unusual smell while using, stop using immediately and unplug the power cord.</li> </ul>
 <b>NO DISASSEMBLY</b>	<ul style="list-style-type: none"> <li>Do not disassemble this chair.</li> <li>Do not dismantle, fix or modify the chair yourself; please contact an authorized dealer or service agent.</li> </ul>
 <b>UNPLUG THE POWER CORD</b>	<ul style="list-style-type: none"> <li>Fully unplug the power cord before maintenance or moving. Never plug-in or pull out power cord with damp hands, to avoid shock or injury.</li> <li>Unplug the power cord when chair is not in use.</li> <li>Unplug from outlet when the power supply is cut, and switch all controls to off.</li> </ul>

## ▶ SPECIAL FEATURES

### FUNCTIONS AND FEATURES

#### One-Press Control Forward-Sliding Recline

- ▶ The “Wall Hugger” feature of the chair is designed to save space and allow the chair to be placed close to a wall. Before reclining the chair will slide forward 11 in. then reclines to provide the utmost relaxing position.

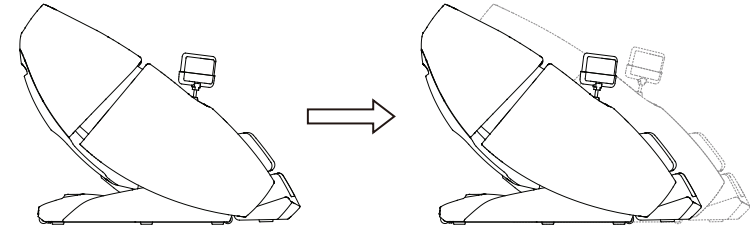

#### Zero Gravity Position

- ▶ Positions the feet slightly higher than the heart, distributing the weight evenly and removing downward pressure from joints and organs. It reduces pressure which may help with pain and discomfort, allowing your mind and body to relax and recharge.

#### Automatic and Manual Leg Extension

- ▶ To ensure a perfect fit the footrest can extend automatically to customize the user’s leg length, you may also use the controller button to adjust the footrest according to your needs. The upper legrest can extend by 2.7 in. and lower footrest can extend by 5.9 in. automatically for various users with different stature.

#### Whole Body Air Pressure Massage

- ▶ Massage nearly every major muscle group thanks to the dozens of layered airbags that inflate and deflate to give you a soothing therapeutic massage treatment.

#### Reflexology Foot Rollers

- ▶ Positioned at the base of the legrest beneath the soles of your feet are three-row rollers that stimulate acupuncture points and provide hand simulation rolling and shiatsu massage.

#### FullBodyReach™ MultiStroke 6-Roller System

- Two separate massage roller systems with a combined six massage rollers. The rollers
  - ▶ mimic the human hand and massage the neck and shoulders separately from the lower body. The massage techniques include kneading, knocking, sync, tapping, shiatsu with extra calf rubbing massage for custom-tailored relaxation.

## SPECIAL FEATURES

### HybriFlex™ Flexible Massage Track

- ▶ The new flexible massage track allows for a greater reach of the massaging arms and for a deeper stretch of the inversion stretch features. Enjoy the benefits of two massage chair styles in one.

### Off-line Voice Control

- ▶ Intelligent voice control system allows to start massage programs and make adjustments without lifting a finger.

### Aromatherapy

- ▶ The new aromatherapy feature can help promote relaxation using more of the body senses. This feature can be turned on or off.

### Wireless Charger

- ▶ Enjoy charging your smart phone wirelessly with the Qi charger on the armrest. Not all phones allow for wireless charging, please check your phone manual to see if it is available.

### Air Ventilation Cushion with Cooling Fan

- ▶ The built-in air ventilation cushion with cooling fan keeps you cool while you enjoy the massage. Since the massage helps to boost your blood circulation your body temperature will increase during the massage.

### Independent Heat Control

- ▶ The fast-heating system provides steady warmth for your back, legs, or feet. Each section can be controlled independently to target one area, or all can be turned on to provide warmth to the whole body.

### Heart Rate Sensor

- ▶ The heart rate sensor is located on the right armrest. It is positioned so it can detect Heart Rate (BMP), Blood Oxygen (%), Microcirculation (%), and HRV while you are enjoying the massage.

### Intelligent Massage

- ▶ The Intelligent Massage creates a unique massage experience tailored to you based on the reading of the Heart Rate Sensor.

## PARTS

### EXTERNAL STRUCTURE

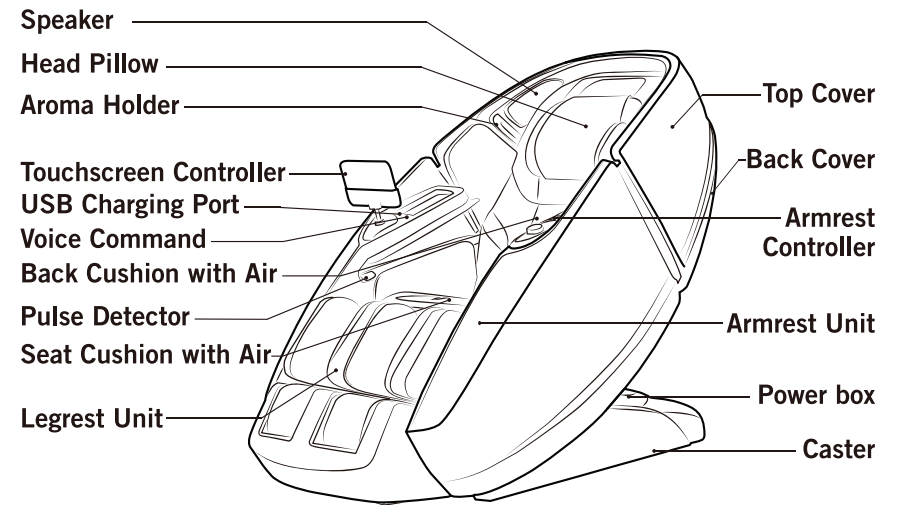

### INTERNAL STRUCTURE

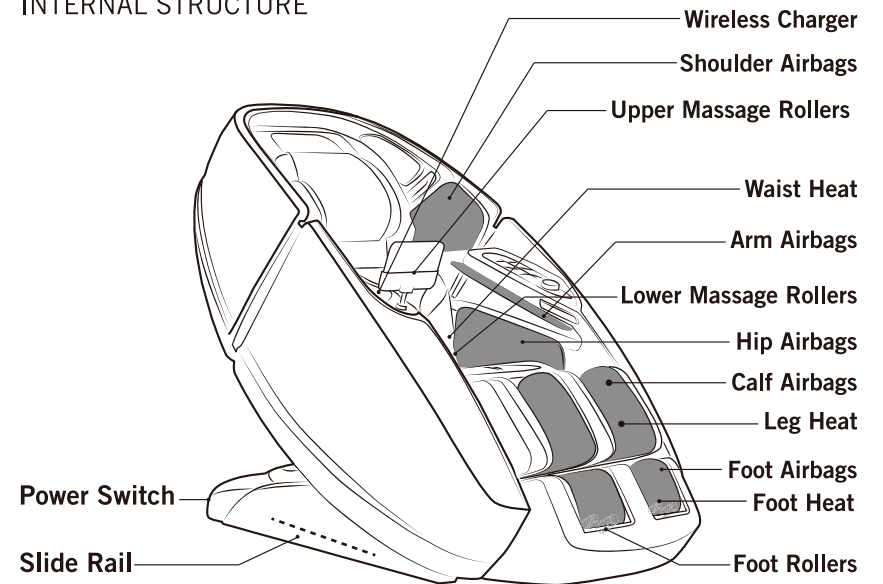





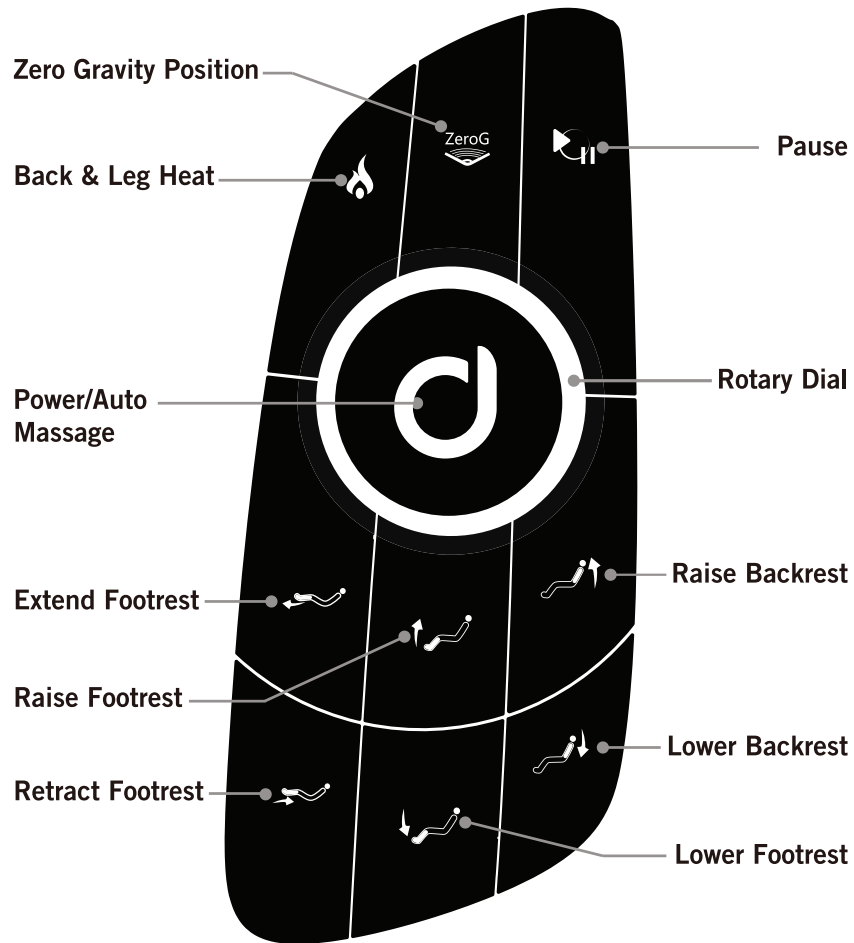



## ▶ PARTS

### ARMREST QUICK BUTTONS



## ▶ MESSAGE CHAIR OPERATION

### ARMREST CONTROLLER FUNCTIONS

-  **Power/Auto Massage**
  - ▶ Long-press to turn on the unit. Quick press to toggle auto massage programs.
  - ▶ Long-press again to turn off all functions.
-  **Rotary Switch**
  - ▶ Rotate to adjust the strength of the 3D rollers during an Auto Mode or Manual Mode massage program.
  - ▶ Rotate clockwise to increase the 3D massage intensity, rotate counterclockwise to decrease intensity.
  - ▶ During a 3D Mode massage program, the roller strength is set automatically.
-  **Back & Leg Heat**
  - ▶ Press to turn Heat on or off.
-  **Zero Gravity Position**
  - ▶ Press to turn on Zero Gravity position massage.
  - ▶ Press again for Zero Gravity mode 2.
  - ▶ Press again to turn off Zero Gravity.
-  **Pause**
  - ▶ Press to pause all functions, press again to resume.
-  **Extend Footrest**
  - ▶ Press and hold to extend the footrest, release to stop.
-  **Retract Footrest**
  - ▶ Press and hold to retract the footrest, release to stop.
-  **Raise Footrest**
  - ▶ Press and hold to raise the footrest, release to stop.
-  **Lower Footrest**
  - ▶ Press and hold to lower the footrest, release to stop.

## ▶ MESSAGE CHAIR OPERATION



### **Raise Backrest**

▶ Press and hold to lower the backrest, release to stop.



### **Lower Backrest**

▶ Press and hold to lower the backrest, release to stop.

## TOUCHSCREEN CONTROLLER

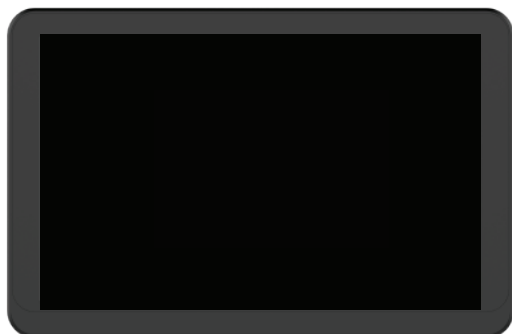

### **Instructions:**

- ▶ Navigate the menus using the Touchscreen Controller. If you are having any problems with the Touchscreen Controller, make sure that it is properly connected to the chair via Bluetooth.
- ▶ For the complete Touchscreen Controller user guide tap “Settings” and navigate to “User Guide.”



### **WARNING**

- ▶ Do not operate the control panel with wet hands to avoid electric shock or injury.
- ▶ Do not spill water or other liquid into the controller to avoid fault.

## ▶ MESSAGE CHAIR OPERATION

### VOICE COMMAND

Get quick access your chair's most used settings without using the handheld controller by using the Voice Command feature. The Supreme Hybrid X speaks multiple languages. Switch the language to Chinese, on the controller, to speak to the Supreme Hybrid X in Chinese. Find the Chinese command list on [daiwamassage.com](http://daiwamassage.com).

### **Instructions**

To activate Voice Command, say “Hello, Daiwa.” The chair will respond and then will wait for a command. After activating, you have 15 seconds to say your command (see list below). After 15 seconds, it will deactivate and you will need to activate again with “Hello, Daiwa.” Once activated, you can use more than one command, but only one at a time. After a command & reply, you can then say another command.

Your Command	Message Chair Reply	Description of Action
"Hello, Daiwa."	Hello, what can I do for you?	Activates Voice Command feature and waits for a command.
"Turn On"	Ok, turning chair on.	Turns on chair's main power.
"Turn Off"	OK, power off.	Turns chair's main power off.
"HybriFlex"	OK, HybriFlex.	Starts an Auto massage program in HybriFlex Mode.
"Royal Treatment"	OK, royal treatment.	Starts an Auto massage program in Royal Treatment Mode.
"Refresh Massage"	OK, refresh massage.	Starts an Auto massage program in Refresh Mode.
"Breathe Massage"	OK, breathe massage.	Starts an Auto massage program in Breathe Massage Mode.
"Recovery Massage"	OK, recovery massage.	Starts an Auto massage program in Recovery Mode.
"Stress Relief"	OK, stress relief.	Starts an Auto massage program in Stress Relief Mode.
"Deep Shiatsu"	OK, deep shiatsu.	Starts an Auto massage program in Deep Shiatsu Mode.
"Traditional Massage"	OK, traditional massage.	Starts an Auto massage program in Traditional Massage Mode.

## ▶ MESSAGE CHAIR OPERATION

Your Command	Message Chair Reply	Description of Action
"Neck & Shoulder"	OK, neck and shoulders.	Starts an Auto massage program in Neck & Shoulders Mode.
"Lower Body"	OK, lower body.	Starts an Auto massage program in Lower Body Mode.
"Back & Spine"	OK, back and spine.	Starts an Auto massage program in Back & Spine Mode.
"Leg & Foot"	OK, leg and foot.	Starts an Auto massage program in Leg & Foot Mode.
"Relaxation Message"	OK, relaxation massage.	Starts an Auto massage program in Relaxation Massage Mode.
"Extend Massage"	OK, extend massage.	Starts an Auto massage program in Extend Massage Mode.
"Light Stretch"	OK, light stretch.	Starts an Auto massage program in Light Stretch Mode.
"Gentle Touch"	OK, gentle touch.	Starts an Auto massage program in Gentle Touch Mode.
"Morning Buzz"	OK, morning buzz.	Starts an Auto massage program in Morning Buzz Mode.
"Refreshing Nap"	OK, refreshing nap.	Starts an Auto massage program in Refreshing Nap Mode.
"Sweet Dreams"	OK, sweet dreams.	Starts an Auto massage program in Sweet Dreams Mode.
"Meditation Massage"	OK, meditation massage.	Starts an Auto massage program in Meditation Mode.
"Cool Down"	OK, cool down.	Starts an Auto massage program in Cool Down Mode.
"Deep Release"	OK, deep release.	Starts an Auto massage program in Deep Release Mode.
"Post-run"	OK, post-run.	Starts an Auto massage program in Post-run Mode.

## ▶ MESSAGE CHAIR OPERATION

Your Command	Message Chair Reply	Description of Action
"Gentle Yoga"	OK, gentle yoga.	Starts an Auto massage program in Gentle Yoga Mode.
"Zero Gravity 1"	OK, zero gravity 1.	Starts Zero Gravity 1 Function.
"Zero Gravity 2"	OK, zero gravity 2	Starts Zero Gravity 2 Function.
"Heat On"	OK, heat on.	Turns on Heat Function.
"Heat Off"	OK, heat off.	Turns off Heat Function.

### Tips:

- ▶ For best results, use the exact terminology in the table above and speak clearly and loudly.
- ▶ You can use Voice Command to turn on the chair, but only if the chair is plugged in and the switch on the base of the Power Box is switched to "On."

## ▶ SETUP

### MASSAGE CHAIR PLACEMENT

When looking for a location to place your massage chair, keep the following in mind:

- ▶ Ensure there is an adequate clearance for the installation: be sure to leave 2 in. of clearance for the reclining of the backrest and 24 in. of clearance for the extension of footrest and sliding forward of the chair.
- ▶ Keep unit 40 in. away from the TV, radio or other audio/video appliance to avoid signal interference.
- ▶ The power socket must be within 60 in. on the chair for the cord to reach.

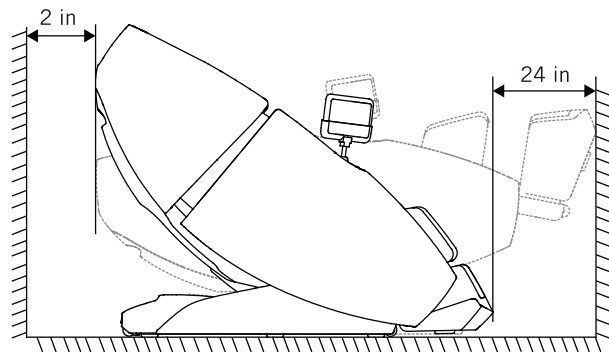

### FLOOR PROTECTION

- ▶ Place the unit on a mat to prevent floor damage.
- ▶ When placing a mat under the unit, the size of the mat should be sufficient to areas where the unit touches and where the legrest could touch the floor (at least 48 in. by 72 in.).

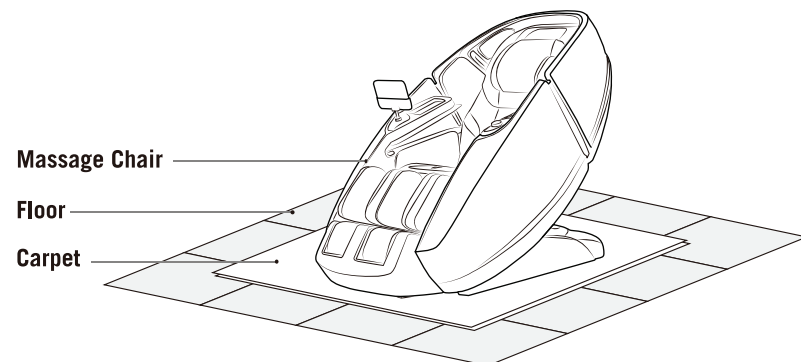

## ▶ SETUP

### INSTALLATION METHOD

#### 1: Take All Massage Chair Units Out of the Cartons

- ▶ Carefully lift chair and all its parts from the packaging.
- ▶ Before beginning installation, verify that all components are included.

#### 2: Install the Armrests

- ▶ Connect the numbered Air Hose to the matching numbered Air Nozzles on the armrest and plug in the Air Valve Connector (there are 2 air valve plugs on each side of the armrest).

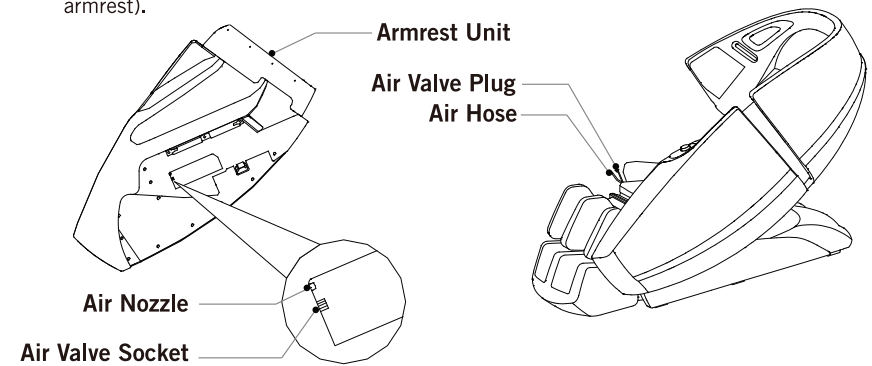

- ▶ Hold the armrest unit up and hook Bracket 2 onto the carrier groove, slowly push the armrest unit back into the chair linkage until Bracket 2 aligns completely with Bracket 4, insert Bracket 1 into Bracket 3, use a screw to secure the armrest into place. Repeat installation method with the other side.

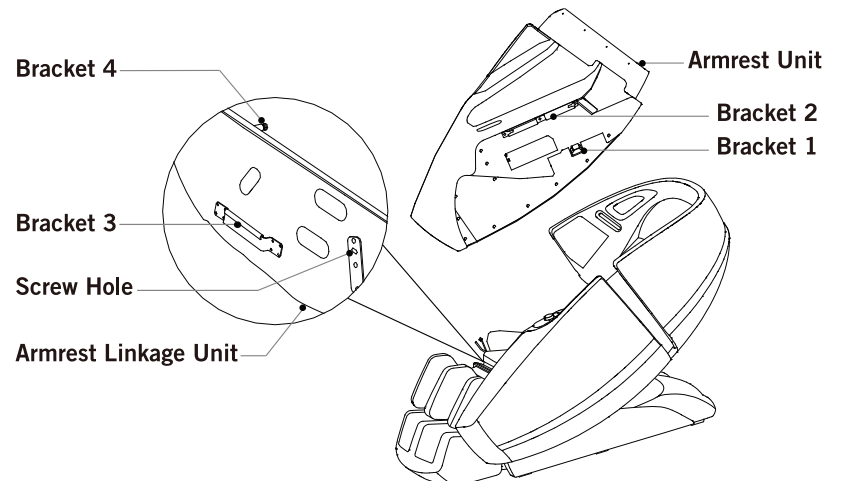

### 3: Install Touchscreen Controller Holder

- ▶ Insert the lower end of Touchscreen Controller holder into the socket, turn the Screw Nut clockwise to secure the holder into place.

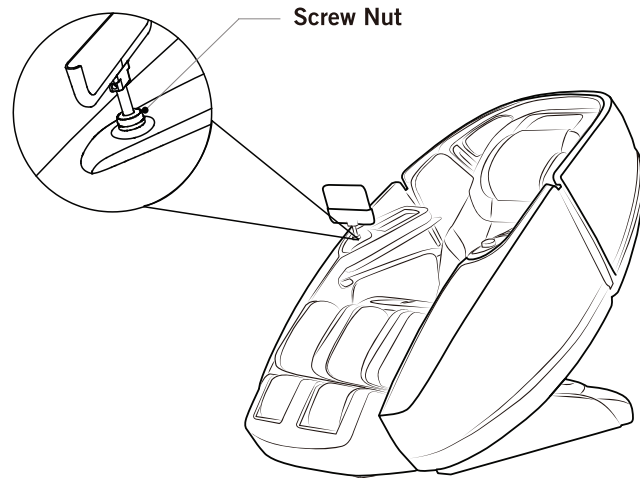

### 4: Install the Legrest Unit: Connections

- ▶ Lift the Legrest Unit to align it with the connecting ports at the base of the front of the chair. Connect the Air Hose into the Air Nozzle, and the Air Valve Plug into the Air Valve Port. Make sure they are well secured.

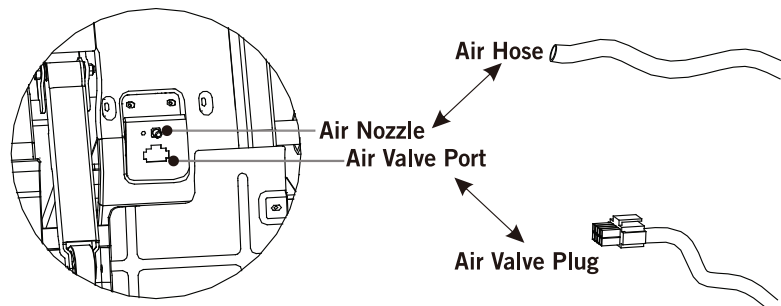

### 5: Install the Legrest Unit: Attaching Unit

- ▶ Put the legrest bracket sleeve into the legrest bracket, attach the legrest bracket onto the legrest rotation shaft, then attach a clip to the end of the legrest rotation shaft to hold the legrest in place, then zip the footrest, and main chair together.

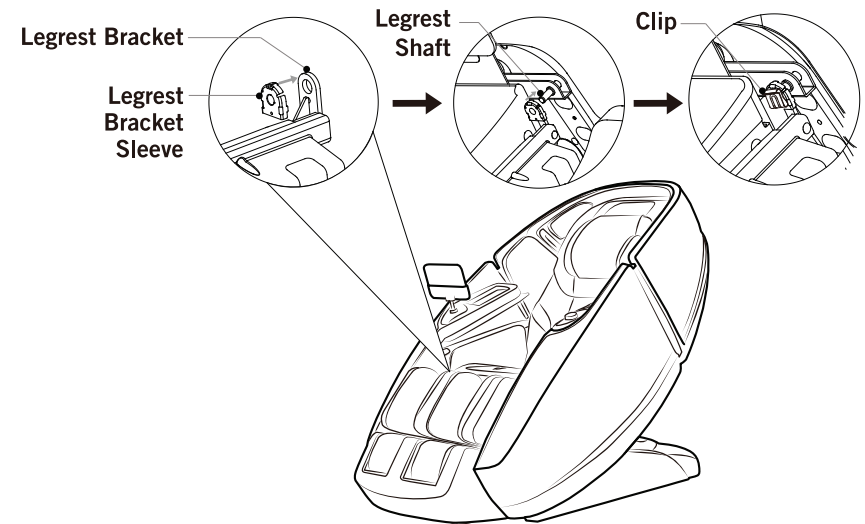

### 6: Aroma Installation

- ▶ Remove the Aroma Cube from the Fragrance Box.
- ▶ Remove the Aroma Outer Cover from the headpiece, gently open the Aroma Cover from the back, place the Aroma Cube in the Aroma Outer Cover slot, cover the aroma box, and then install the assembly into the headpiece.

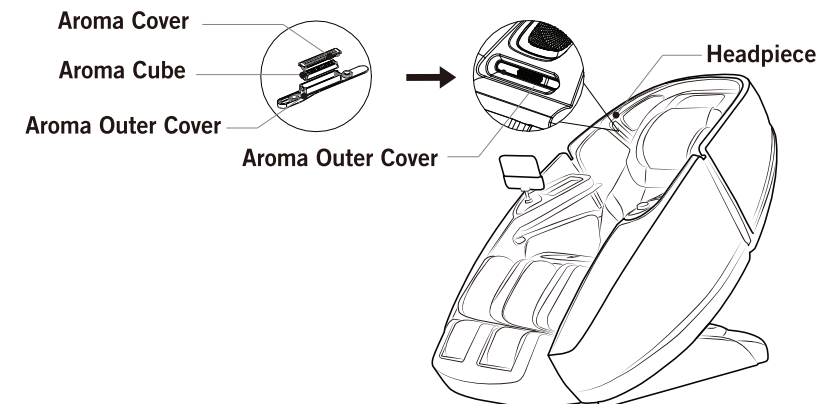

## ▶ SETUP

### 7: Connecting to a Power Source

- ▶ Insert the Power Cord to the Power Port located on the back of the Power Box.
- ▶ Switch the power to ON using the Power Switch on the base of the chair.
- ▶ Use the controller to raise the backrest to fully upright position.

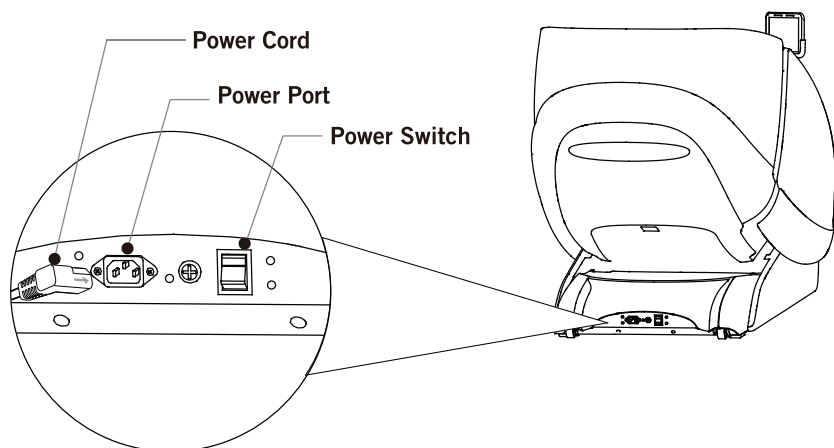

### AFTER USE

- ▶ Always unplug the massage chair from the electrical outlet immediately after use.
- ▶ Put the Touchscreen Controller onto the holder.
- ▶ Turn off the power switch and unplug the massage chair from the electrical outlet while not in use to avoid children power on the massage chair accidentally.
- ▶ When not in use for a long period of time, we recommend that the chair be covered, the power cord be coiled, and that the unit be placed in an environment free of dust and moisture.

## ▶ SETUP

### INITIAL OPERATION

- ▶ Make sure there are no objects, people, or pets in the vicinity of the chair.
- ▶ Use the controller to lower the backrest to its furthest outstretched position.
- ▶ Raise the legrest to its highest position. Make sure that there is sufficient open space around the chair on all sides.
- ▶ Make sure the legrest is properly connected to the chair.
- ▶ Return the chair to its original, upright position. By turning the chair off it will reset to the default position.

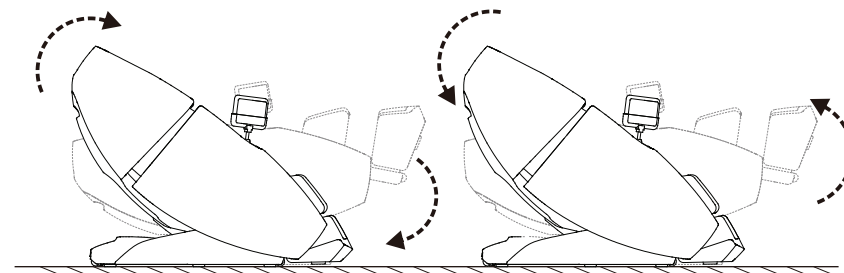

### BEFORE SITTING IN THE CHAIR

- ▶ Ensure the footrest is well assembled before sitting on the massage chair.
- ▶ Ensure the massage chair is returned to its original position before sitting on it. If there is any part not in default position, please turn on the massage chair to allow it to restore.

#### ⚠ CAUTION

- ▶ Do not sit in chair while the legrest is lifted.
- ▶ To avoid possible damage, do not suddenly load legrest with heavy weight.

#### ⚠ WARNING

- ▶ Do not play on the massage chair or operate it improperly.
- ▶ Ensure there is no obstruction when raising or reclining the backrest and footrest.
- ▶ Do not put feet, fingers, or any other objects in the openings of the chair when it is in the reclining, raising or restoring motion.
- ▶ Ensure that massage chair is restored back to its original position before getting off the massage chair.
- ▶ To prevent shock do not operate this chair within damp environments.
- ▶ Do not place chair near a stove or other significant source of heat.
- ▶ Do not drag or push the unit in an installed state.

## ▶ SETUP

### MOVE METHOD

- ▶ Roll the chair on its casters to the desired location.
- ▶ Incline the backrest to upright position.
- ▶ Turn off the power switch and unplug the appliance from the electrical outlet.
- ▶ Using two people push down on the backrest and lift on the front side by grabbing the moving holder located to the front bottom of the armrest), roll the chair on its casters to the desired location (see sketch for reference).

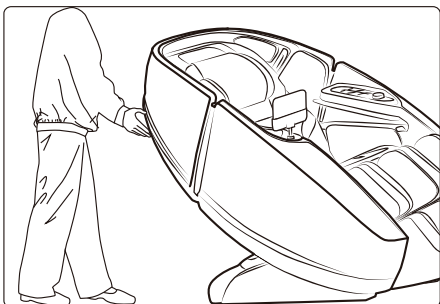

### **⚠ CAUTION**

- ▶ Do not move the chair when there is a user inside.
- ▶ When moving the chair, always grasp it by the backrest. Do not move the chair by pulling its armrests, as the armrest can dislodge.
- ▶ Use 4 or more people to carry the chair.

### CONNECTING TO POWER

- ▶ Connect unit to a 3-wire properly grounded outlet.
- ▶ Make sure the power supply switch is turned OFF before inserting the power plug into the wall outlet.

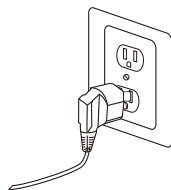

### **⚠ CAUTION**

- ▶ Verify that there is no damage to the supply cord before switching on the unit.
- ▶ Verify that the main power switch is turned off before connecting to power.

## ▶ SETUP

### GROUNDING INSTRUCTIONS

- ▶ This product must be grounded. If it should malfunction or break down, grounding provides a path of least resistance for electric current to reduce the risk of electric shock. This product is equipped with a cord having an equipment-grounding conductor and a grounding plug. This plug must be plugged into an appropriate outlet that is properly installed and grounded in accordance with all local codes and ordinances.

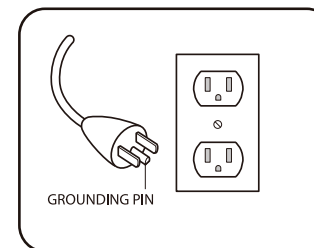

### **⚠ DANGER**

- ▶ Improper connection of the equipment-grounding conductor can result in a risk of electric shock. Check with a qualified electrician or serviceman if you are in doubt as to whether the product is properly grounded. Do not modify the plug provided with the product – if it will not fit the outlet, have a proper outlet installed by a qualified electrician.
- ▶ This product is for use on a nominal 120-volt circuit and has a grounding plug that looks like the plug illustrated. Make sure that the product is connected to an outlet having the same configuration as the plug. No adapter should be used with this product.

- ▶ This massage chair belongs to Class 1 of the IEC Protection Class. Be sure to use a three-core power supply socket. To avoid electric shock, leakage, or other electric risk ensure the ground wire connected to the power supply has obtained a stable ground connection.

## ▶ STORAGE AND MAINTENANCE

### CLEANING

- ▶ Before cleaning, switch off power and remove the power plug from the wall outlet.
- ▶ Dip a soft, cotton cloth in neutral detergent and wring dry. Use it to wipe the pillow cushion, back cushion, armrests, legrests, and any plastic parts of the chair.
- ▶ Use a piece of wet cloth (without detergent) to re-wipe the pillow cushion and back cushion. Place them in a well-ventilated location for drying.
- ▶ Use a soft, dry cloth to re-wipe the armrests, legrests, and any plastic parts of the chair.
- ▶ Use a soft, dry cloth to wipe the controller, and the power supply box.

#### CAUTION

- ▶ Before any maintenance, always disconnect the power plug from the wall outlet.
- ▶ To avoid electric shock, never touch the power plug with wet hands.
- ▶ When cleaning the back cover of the massage chair, do not allow any detergent to seep into the power supply box.
- ▶ Do not use abrasive chemicals, such as benzene or alcohol, to clean this chair. Damage to the chair may result.
- ▶ Do not apply an iron or any other heated device to the chair.

### STORAGE

- ▶ Before putting into storage, wipe off all accumulated dirt and dust from the surface of the chair. Cover the entire surface of the chair with a dust cover (not included).

#### CAUTION

- ▶ Do not store the product under direct sunlight, nor in a location with high temperatures. Doing so may cause the upholstery to fade.

### MAINTENANCE

Upon detecting any of the following conditions during daily use, immediately turn off power, disconnect the power plug from the wall outlet, and contact an authorized repairman:

- ▶ A burning smell
- ▶ The power cord feels hot.
- ▶ Any other abnormal symptoms
- ▶ The cord is plugged in and the power switch flipped on, but no functions operate.

#### CAUTION

- ▶ Do not store the product under direct sunlight, nor in a location with high temperatures. Doing so may cause the upholstery to fade.

## ▶ TROUBLESHOOTING

No.	Problem	Check the following:	Explanations / Remedies
1	Noises are heard during operation	N/A	These noises are normal and arise from friction between the massage rollers and the leather cover.
2	Operation fails to start	Has the power plug slipped out of the wall outlet? Is the power switch in the "off" position? Has the fuse blown out?	Connect the power plug securely to the wall outlet. Switch power to the "on" position. Replace the fuse with another of the same type.
3	Airbags within the seat and the legrest fail to work properly	Are the air tubes blocked?	Clean out the air tubes.
4	Airbags within the seat and the legrest fail to work properly	The massage chair has detected some error that it is unable to display.	Turn off power, then turn it on again. If the problem persists, disconnect the power plug from the wall outlet and contact an authorized repairman

If problems persist after applying the suggestions above, turn off power and remove the power plug from the wall outlet. Then contact the manufacturer for maintenance and repair.

#### IMPORTANT

- ▶ Do not attempt to dismantle or repair the chair by yourself. Doing so will void the warranty and U.S. Jaclean, Inc. will not bear any responsibility for any subsequent consequences.

## TECHNICAL SPECIFICATIONS

---

Product Name: Supreme Hybrid

Product Model: SPH-X

Rated Voltage: 110-120V

Rated Frequency: 60Hz

Rated Current: 135W

Safety Design: Class I