

Osaki

Instruction Manual

Model No. Osaki Pro Admiral

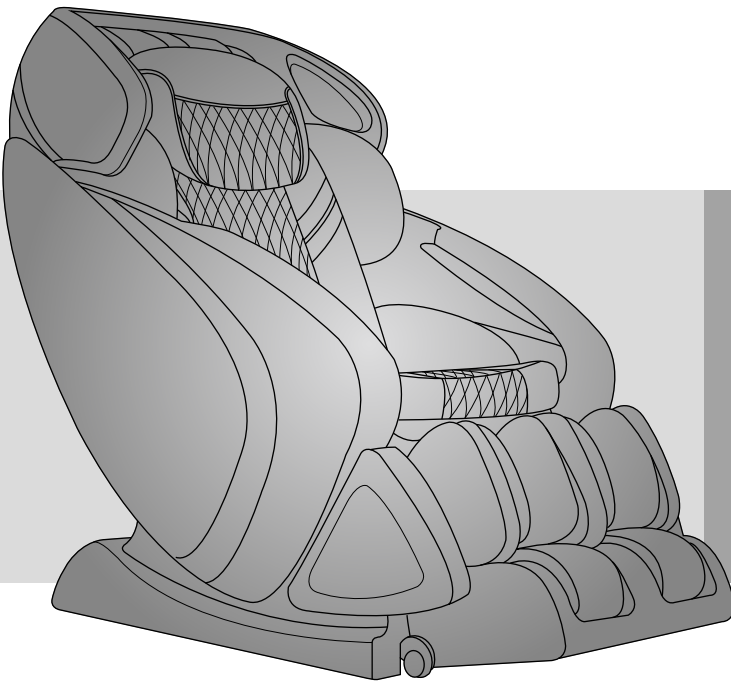

Before operating this unit, please read these instructions completely.

Contents

Before Use

IMPORTANT SAFETY INSTRUCTIONS	1
Safety Precautions	2-3
FCC Radiation Exposure Statement.....	4
Chair Components	5
• Bluetooth Speaker	5
Setting up the massage chair	6
Chair Installation.....	7-11
Preparation before Use	12-13

How to Use

Controller	14
How to Use.....	15-22

Q&A / Important

Cleaning and maintenance	23
Troubleshooting	24
Grounding Instructions.....	25
Chair Specifications.....	26

Thank you for purchasing this Massage Chair.
Before using your massage chair, please read the contents of this instruction manual and refer to it when needed.

IMPORTANT SAFETY INSTRUCTIONS

When using an electrical appliance, basic precautions should always be followed, including the following:

Read all instructions before using (this appliance).

DANGER To reduce the risk of electric shock:

- Always unplug this appliance from the electrical outlet immediately after using and before cleaning.
- Never use pins or other metallic fasteners with this appliance.
- Carefully examine the covering before each use. Discard the appliance if the covering shows any sign of deterioration, such as checking, blistering, or cracking.

WARNING To reduce the risks of burns, fire, electric shock or injury to persons:

- An appliance should never be left unattended when plugged in. Unplug from outlet when not in use, and before putting on or taking off parts.
- Close supervision is necessary when this appliance is used by, on, or near children, invalids, or disabled persons.
- Use this appliance only for its intended use as described in this manual. Do not use attachments not recommended by the manufacturer.
- Never operate this appliance if it has a damaged cord or plug, if it is not working properly, if it has been dropped or damaged, or dropped into water. Return the appliance to a service center for examination and repair.
- Do not carry this appliance by supply cord or use cord as a handle.
- Keep the cord away from heated surfaces.
- Never operate the appliance with the air openings blocked. Keep the air openings free of lint, hair, and the like.
- Never drop or insert any object into any opening.
- Do not use outdoors.
- Do not operate where aerosol (spray) products are being used or where oxygen is being administered.
- To disconnect, turn all controls to the off position, then remove plug from outlet.
- Keep children away from extended foot support.
- Connect this appliance to a properly grounded outlet only. See Grounding Instructions.
- Use heated surfaces carefully. May cause serious burns. Do not use over insensitive skin areas or in the presence of poor circulation. The unattended use of heat by children or incapacitated persons may be dangerous.
- Do not operate under blanket or pillow. Excessive heating can occur and cause fire, electric shock, or injury to persons.

SAVE THESE INSTRUCTIONS

Safety Precautions

When using the massage chair, basic precautions should always be followed to reduce the risk of electric shock, burns, fire or injury to persons. Please read the following precautions before using the massage chair.

- Make sure the power plug is securely inserted into a proper electrical outlet to reduce the risk of short-circuit and fire.
- It is highly recommended that a surge protector is used to prevent from damage.
- DO NOT use the massage chair in areas where the humidity is high such as sauna steam rooms, pools, bathrooms, AC or heating vents, etc.
- DO NOT use the massage chair outdoors and avoid areas with direct sunlight.
- If the chair is not being used, turn the power switch to the OFF position and unplug the massage chair from the electrical outlet to prevent any damages to the chair when there are power outages/surges that may cause serious damage.
- Never plug/unplug the power cord plug socket with wet hands.
- Close and continuous supervision is necessary when the massage chair is used by, on or near children or disabled persons.
- No more than one person should use the massage chair at the same time.
- The massage chair is intended for use as described in the Instruction Manual. Do not use any attachments other than those recommended by the manufacturer.
- DO NOT attempt to stand or sit on the backrest, armrest or footrest in order to prevent accident, injury or damage to the chair.
- Avoid falling asleep while using the massage chair.
- Always keep the massage chair clean, and never insert any objects into or around the gaps of the massage chair.
- DO NOT move the massage chair by pulling on the power supply cord.
- Make sure there are no children, pets or other obstacles behind or underneath the massage chair.
- If you find any rips or tears in the fabric of the massage chair, contact the service department and stop using the chair immediately.
- This massage chair is designed for household use and should not be used in non-residential settings.

Safety Precautions

- Please consult your doctor if you are in doubt as to whether or not you should use this massage chair.
- Please consult a doctor before using the massage chair if you are pregnant, undergoing any medical treatment, using a medical electronic device such as a pacemaker, or are experiencing any of the following: malignant tumor, heart disease, back pain, abnormal or curved back bone, osteoporosis or acute illness.
- If you experience pain while using the massage chair, stop using the chair immediately and consult your doctor.
- Never use a massage function on swollen or inflamed parts of the body.
- DO NOT use the massage chair for more than 30 minutes at a time.
- DO NOT use the massage chair where aerosol(spray) products are being used or where oxygen is being administered.
- This massage chair is a non-professional product designed to provide a comfortable massage and should not be substituted for appropriate medical treatment.
- Never operate the appliance with the air hoses that inflate while they are blocked. Keep the air openings free of lint, hair, and any other obstructions.
- Check the skin which is in contact with the heated area of the appliance frequently to reduce the risk of injury. If the heating pad malfunctions and extreme heat is produced it may cause serious burns.
- Burns may result from improper use. If this is the case immediately shut off the chair and unplug from the outlet.
- Remove all sharp objects from the body and pockets such as keys and pens.
- Keep children away from extended foot support (or other similar parts.)
- DO NOT WET-DO NOT USE PINS.
- NEVER REMOVE COVER.

Caution

The user's weight is usually limited to 220 lbs.

For those who are weighing 220 lbs or more, the product operations may make more noise and the fabric cover may wear out faster.

FCC Radiation Exposure Statement

FCC Radiation Exposure Statement: (mobile device)

This equipment complies with FCC radiation exposure limits set forth for an uncontrolled environment. In order to avoid the possibility of exceeding the FCC radio frequency exposure limits, Human proximity to the antenna shall not be less than 20cm (8 inches) during normal operation.

FCC STATEMENT

1. This device complies with Part 15 of the FCC Rules. Operation is subject to the following two conditions:
 - (1) This device may not cause harmful interference, and
 - (2) This device must accept any interference received, including interference that may cause undesired operation.
2. Changes or modifications not expressly approved by the party responsible for compliance could void the user's authority to operate the equipment.

This equipment has been tested and found to comply with the limits for a Class B digital device, pursuant to part 15 of the FCC Rules. These limits are designed to provide reasonable protection against harmful interference in a residential installation. This equipment generates, uses and can radiate radio frequency energy and, if not installed and used in accordance with the instructions, may cause harmful interference to radio communications. However, there is no guarantee that interference will not occur in a particular installation. If this equipment does cause harmful interference to radio or television reception, which can be determined by turning the equipment off and on, the user is encouraged to try to correct the interference by one or more of the following measures:

- Reorient or relocate the receiving antenna.
- Increase the separation between the equipment and receiver.
- Connect the equipment into an outlet on a circuit different from that to which the receiver is connected.
- Consult the dealer or an experienced radio/ TV technician for help.

Chair Components

Front

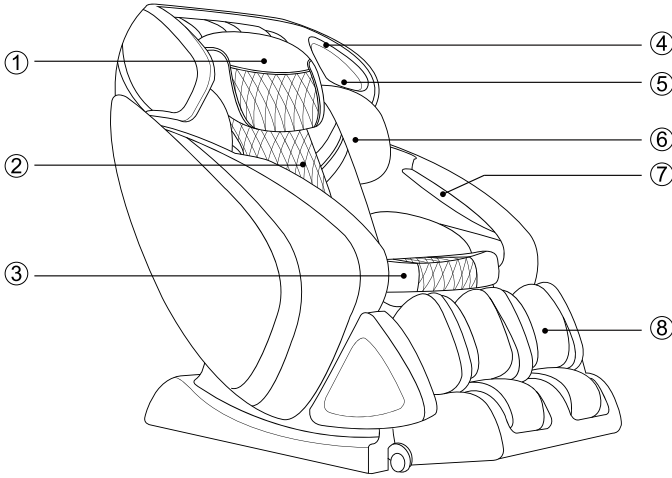

① Pillow Pad

② Backrest Pad

③ Seat Cushion

④ LED Light

⑤ Bluetooth Speaker

⑥ Shoulder side massage section

⑦ Hand and arm massage section

⑧ Legrest

Bluetooth Speaker

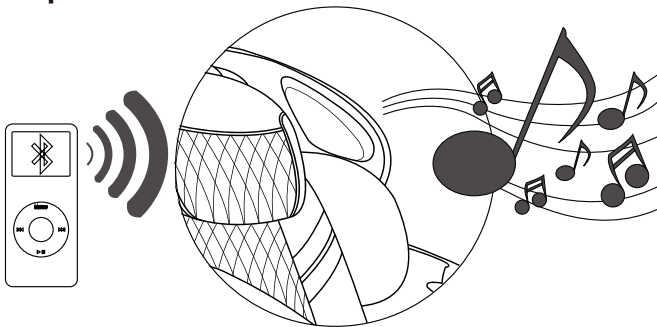

NOTE:

The bluetooth speaker can only connects with one bluetooth device at a time. Please turn off your bluetooth device after using so that other users can enjoy it as well.

Setting up the massage chair

1. Installation Position.

- The chair provides a slide forward function that user can save space and place it very close to the wall.

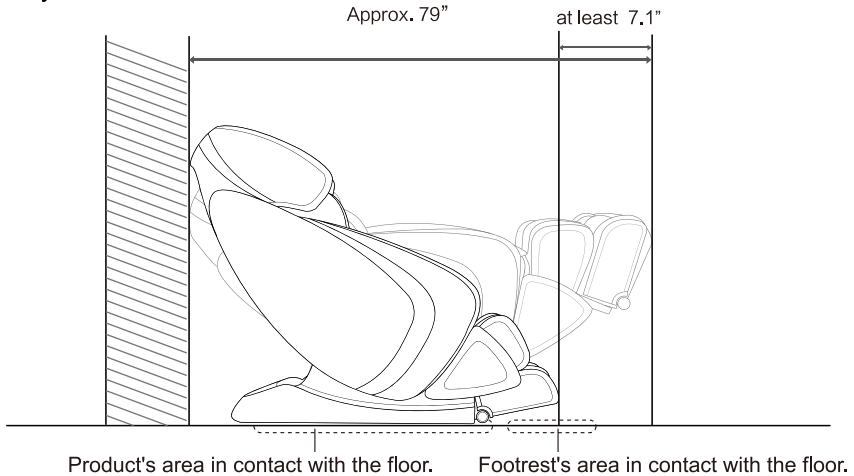

- Do not expose the massage lounger to direct sunlight or high temperatures, such as in front of heating sources, because this can cause discoloration or hardening of the synthetic leather.
- Place the unit on a mat to prevent floor damage.
- When placing a mat under the unit, the size of the mat should be sufficient (at least 71" x 35") to cover the areas where the unit touches and where the legrest could touch the floor, as shown in the diagram on the above.
- Install the unit near a power outlet.

Chair Installation

Step 1: Preparation before Installing.

1. Remove the chair parts out of two cartons: ① Main unit ② Legrest
2. Before installing, please check all the parts according to the following list.

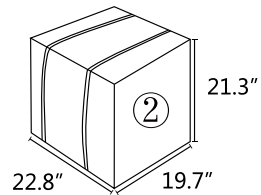
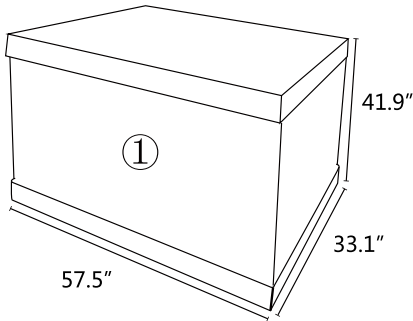

NO.	Part List	Qty.	NO.	Part List	Qty.
1	Main Unit	1	7	Spacer	4
2	Legrest	1	8	Allen Key	1
3	Legrest Baffle (L)	1	9	Circlip	2
4	Legrest Baffle (R)	1	10	Flat Head Rivet	2
5	Power Cord	1	11	Split Pin	2
6	Allen Screw	4			

Chair Installation

Step 2: Install legrest baffles

1. Take out these units as picture shows.

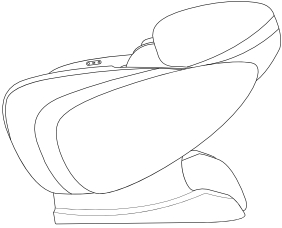

Main Unit

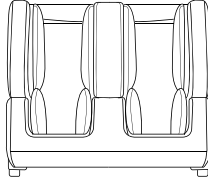

Legrest

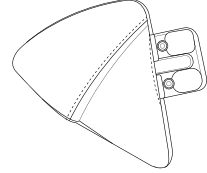

Legrest baffles (a pair)

2. Insert the right baffle(R) into the groove on the right side of main unit, and align the A1 to A2 , B1 to B2.

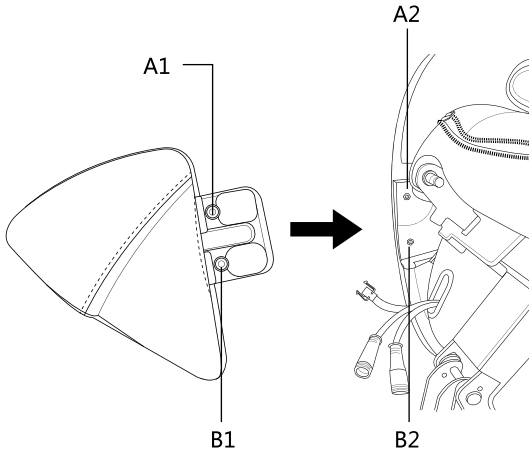

Chair Installation

3. Fasten A1 - A2 and B1 - B2 with the allen screws & spacers by the allen key provided.

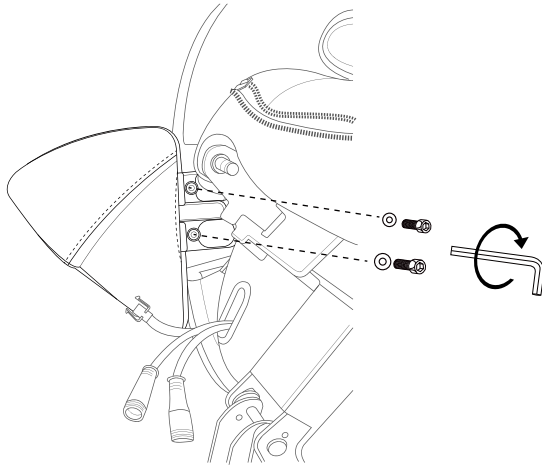

How to tighten the screws

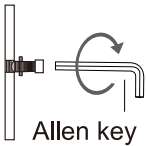

- Put and attachment screw on the edge of the allen key and tighten the screw horizontally to the hole.
- Screw may be damaged if you tighten the screw inserted into the hole crookedly using an allen key.

4. Repeat above steps to accomplish the installation for legrest baffle (L).

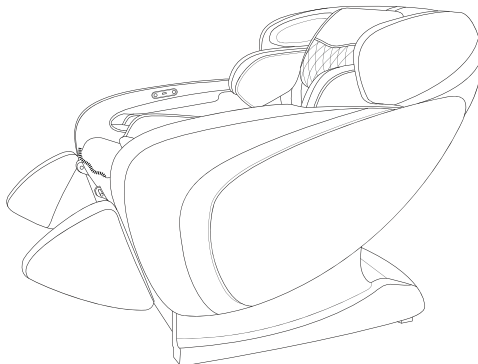

Chair Installation

Step 3: Install the legrest

1. Connect the air connector: E2 (on legrest) and E1 (on main unit).
2. Connect the electrical connector: F1, G1 (on legrest) and F2, G2 (on main unit).

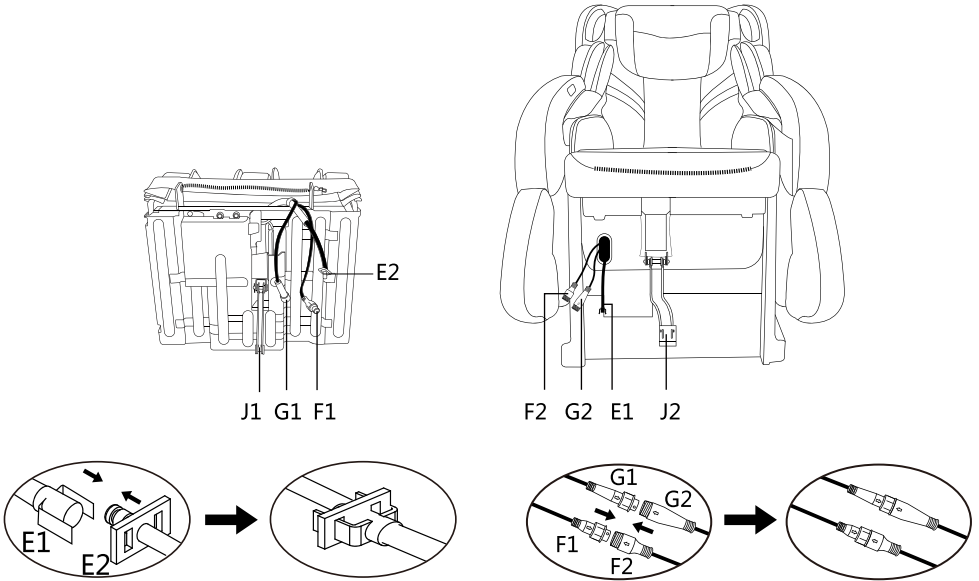

3. Align the push-rod J1 (on legrest) and push-rod J2 (on main unit) with flat head rivets and secure them with split pins.

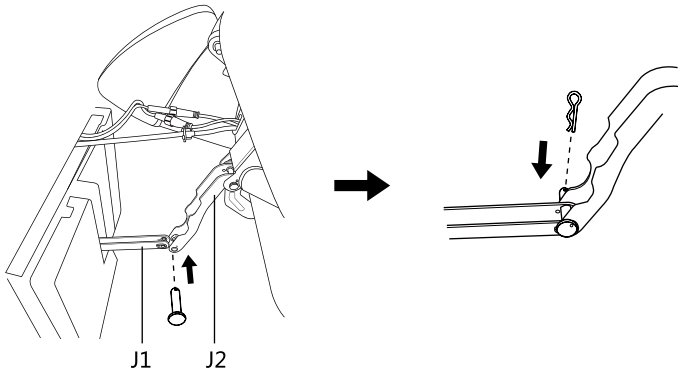

Chair Installation

4. Align the hole H2 (on legrest) to the shaft H1 (on main unit). Let H1 pass through H2. Lock the shafts with the circlips provided.

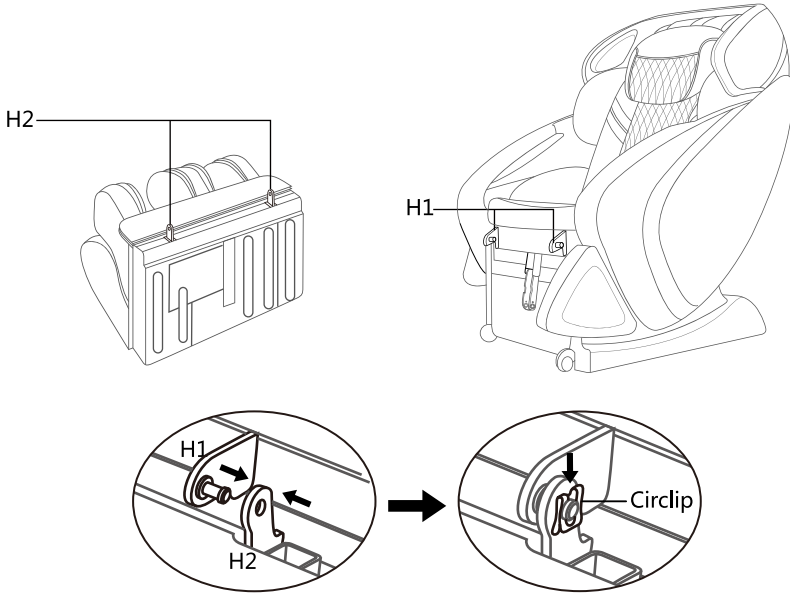

5. Zip the zipper connecting legrest and seat cushion.

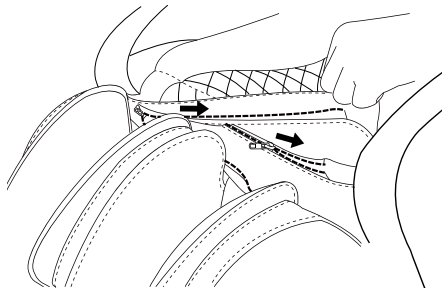

Installation completed.

Preparation before Use

1. Check the space around the product.

Make sure there is no person, pet, or other object close to the product.

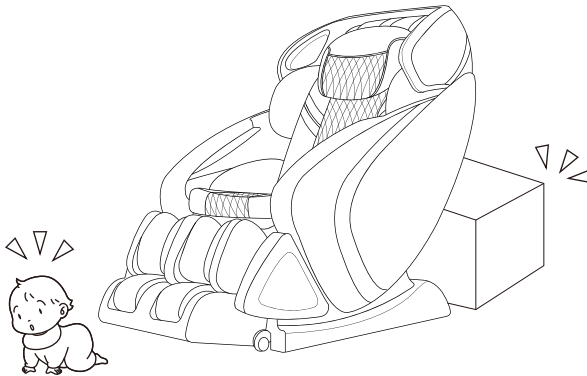

2. Make sure there is no foreign matter in the seams of the product.

- Before sitting on the product, make sure there is no foreign matter between any two parts of it.
- Do not put hands, arms or head between the backrest and the back cover.
- Do not put pets on the product (such as its back cover, backrest and armrests).

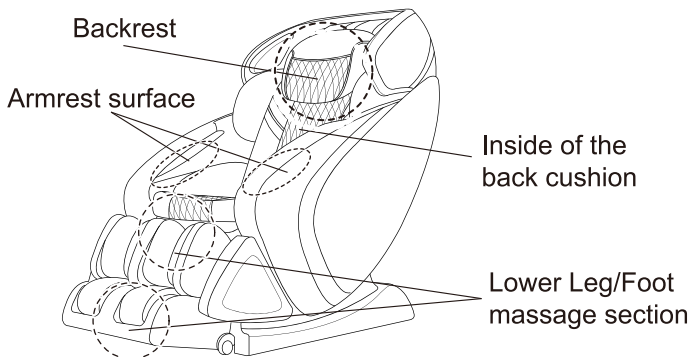

Preparation before Use

3. Power on the product

- ① Push the power connector into the appliance inlet till the end.
- ② Insert the power plug into the power outlet till the end.
- ③ Turn the switch to "I" position

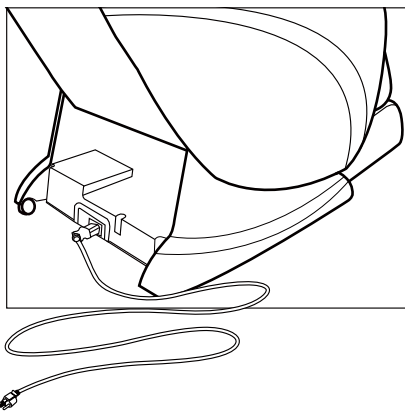
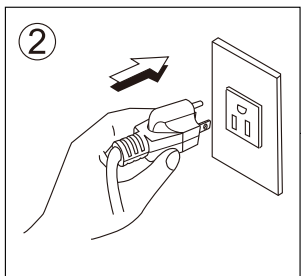
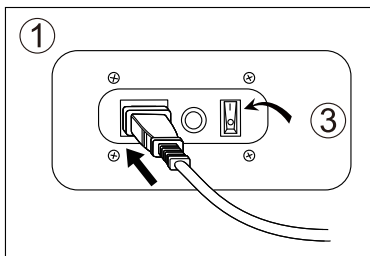

4. Make sure the massage rollers are retracted.

If they are not, press ON button to return them to the retracting position.

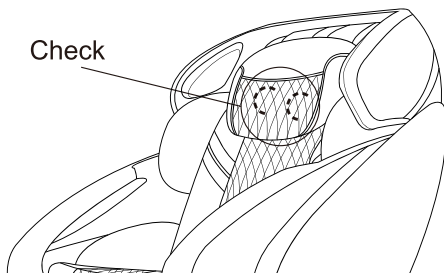

How to Use

Controller

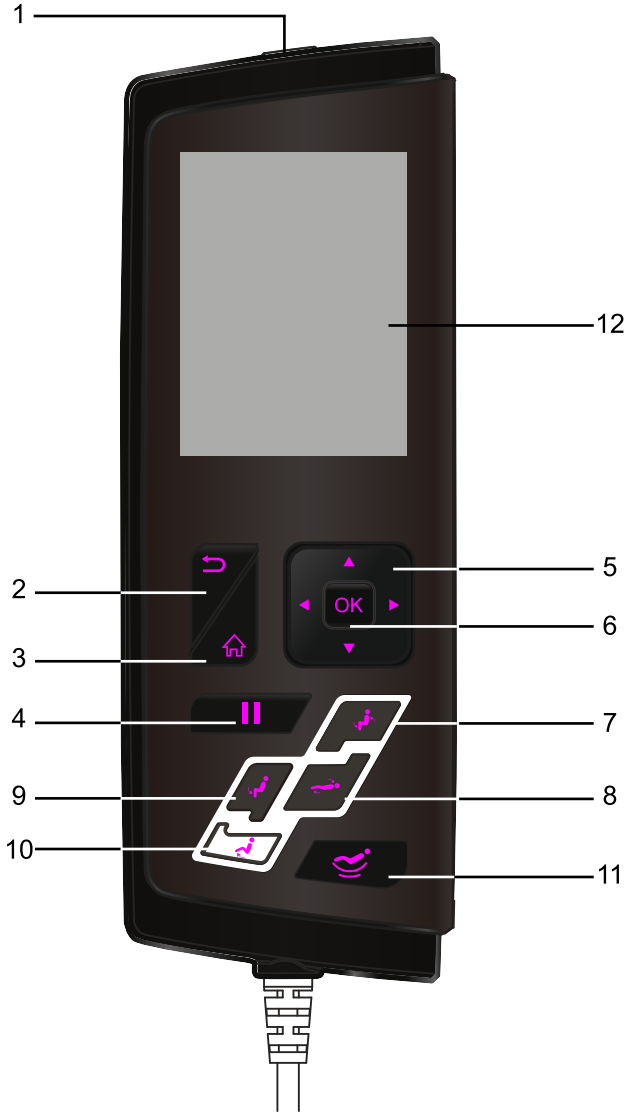

How to Use

1. On/Off button

Press once to turn the power on. Press again to turn the power off.

2. Return button

Back to previous page.

3. Home button

Back to home page.

4. Pause button

Press this button to stop all the functions immediately.

Button light will be on when Pause function is activated.

Please press again to cease Pause function before using any other functions.

5. Position button

Use these arrow buttons to select one of the icons in the page.

6. OK button

7/8. Backrest angle controller

Press once to recline/incline the backrest.

Press again to stop at the angle you desire.

9/10. Legrest angle controller

Press once to lift/drop the legrest.

Press again to stop at the angle you desire.

Long press to extend/retract the legrest.

Loose to stop at the position you desire.

11. Zero-Gravity button

Press once to achieve the angle of the massage chair to zero gravity position 1.

Press again to enter zero gravity position 2.





Press again to resume to original position.

When the zero gravity is activated, the light of the button will be on.

12. Display

How to Use



Quick start guide

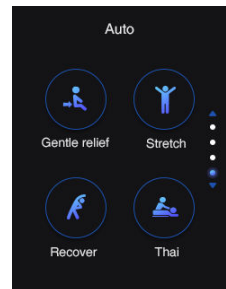
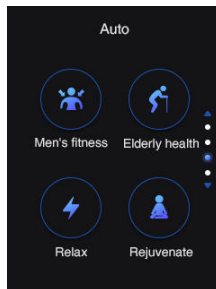
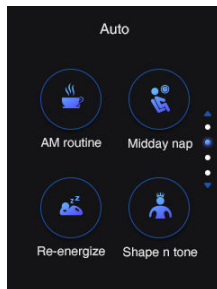
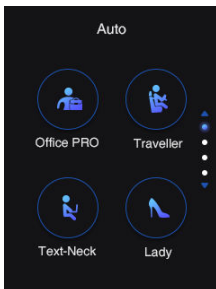
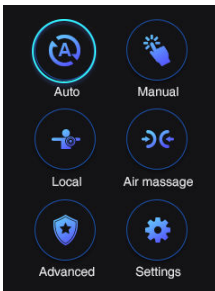



1. Press  to turn the power. The chair will recline into ready position.
(Ready position: Legrest will raise slightly and backrest will recline slightly.)
2. Select Auto and press  to enter the auto program interface.
3. Press  to select any of the 16 automatic massage programs (Office PRO, Traveller, Text-Neck, Lady, AM routine, Midday nap, Re-energize, Shape n tone, Men's fitness, Elderly health, Relax, Rejuvenate, Gentle relief, Stretch, Recover, Thai.) and press  to start chosen massage.
(The massage program begins when initialisation is completed. During the process, you must remain seated with your head resting on the headrest.)



How to Use

Automatic course

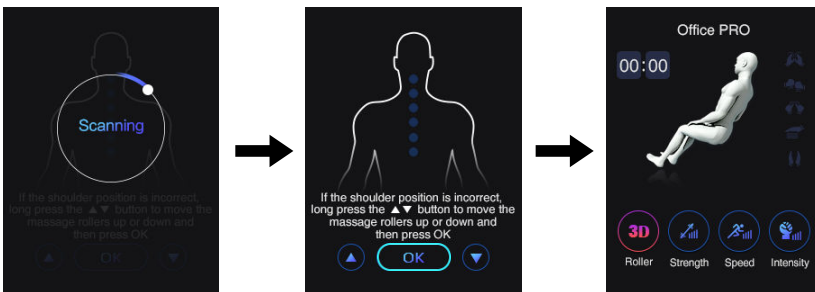
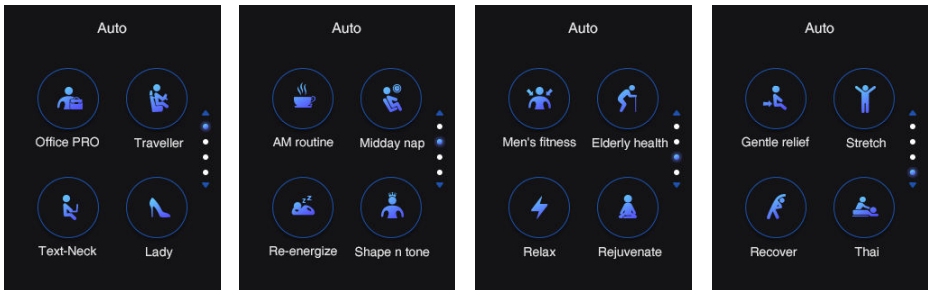

1. Press  to select 1 of the 16 auto programs. Press  to start the massage.
2. Body scanning will commence when the program is selected. (Screen will show Scanning.)
3. Please sit as far back in the seat as possible with your head on the pillow during the scanning.
4. To adjust the shoulder position.

When the shoulder position is incorrect, adjust the shoulder position as the screen shows, select  or  and long press  button to move the massage heads up or down. Select  and press  to complete the adjustment. This adjustment page will last for 10 seconds.







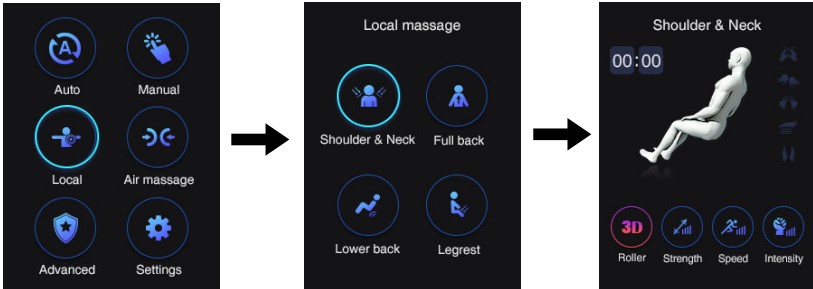

How to Use

Local Programs

1. Press  to select 1 of the 4 local programs.
2. Press  to start the massage.





Adjustment notes:

1. 3D: Select and press  to adjust 3D massage intensity (6 levels).
2. Strength: Select and press  to adjust Kneading strength (5 levels).
3. Speed: Select and press  to adjust Tapping speed (5 levels).
4. Intensity: Select and press  to adjust air massage intensity (5 levels).
5. Select timer icon  and press  to change the timer in the following sequence: 20-25-30-5-10-15 minutes.

In Auto and Local programs, the chair will detect the body curve and set up a optimal track. For this reason, these adjustment are not recommended in Auto and Local programs.

Manual Programs

1. Press  to select 1 of the 6 manual programs.
2. Press  to start the massage.

Note:

There are 2 modes for Kneading, Tapping, K&T, Shiatsu and Clapping. Press once to enter mode 1. Return to previous menu and press again to enter mode 2. When user goes to other operation page, it will return to the current massage page after 10 minutes of user inactivity.

How to Use

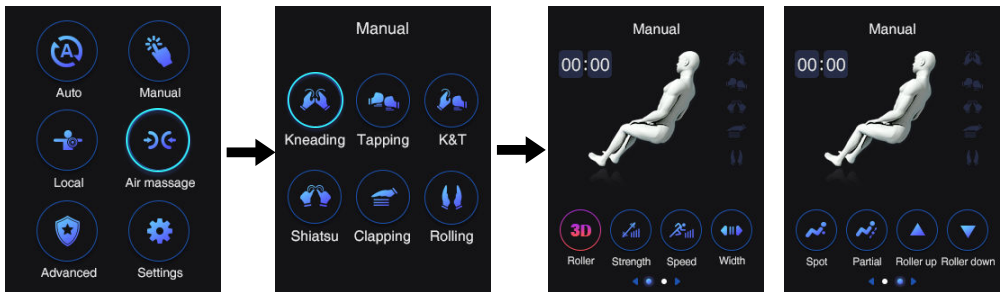

Adjustment notes:

1. 3D: Select and press **OK** to adjust 3D massage intensity (6 levels).
2. Strength: Select and press **OK** to adjust Kneading strength (5 levels).
3. Speed: Select and press **OK** to adjust Tapping speed (5 levels).
4. Width : Select and press **OK** to adjust Rolling width (3 levels).
5. Select timer icon **00:00** and press ok to change the timer in the following sequence: 20-25-30-5-10-15 minutes.
6. Spot: Select this icon and press **OK** to activate spot massage.
The massage roller will spot on the position it goes when user press the button.
Press again to cease spot massage.
7. Partial: Select this icon and press **OK** to activate partial massage.
The massage roller will go up and down in a range of approx 3.2".
Press again to cease partial massage.
8. Roller up: Select this icon and press **OK** to activate roller up function.
The massage roller will keep going up.
9. Roller down: Select this icon and press **OK** to activate roller down function.
The massage roller will keep going down.

How to Use







Air Massage

1. Select 1 of the air massage sections and press ok to start the air massage.
2. Select Intensity and press **OK** to adjust the intensity of air massage (5 levels).





Advanced functions

Music

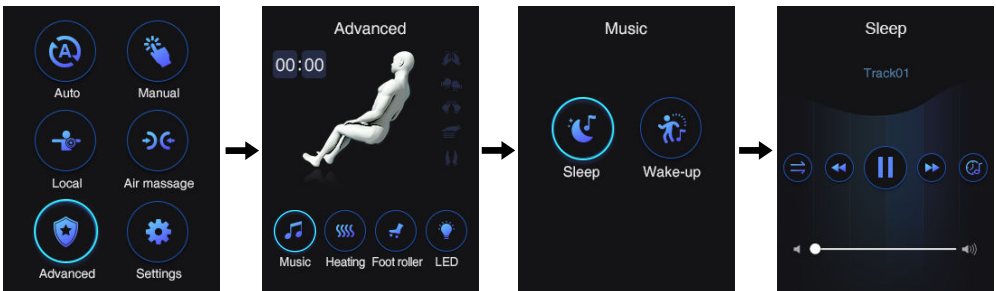
1. Select Music and press **OK** to enter music function. Two kinds of music, Sleep and Wake-up, are for optional.
2. Select one of them and enter to the music play interface.
3. Select  and press **OK** to start playing music.
4. Select  and press **OK** to cease playing music.
5. When it shows , the play mode is List Cycle. Select this icon and press ok to turn to Single Cycle. Press again to back to List Cycle.
6. When it shows , the play mode is Single Cycle. Select this icon and press **OK** to turn to List Cycle. Press again to back to Single Cycle.
7. Select  and press **OK** to play previous track.
8. Select  and press **OK** to play next track.



How to Use

9. Select  and press  to switch the modes between “Music will be off together with the auto massage.” and “Music will continue playing when message is over.”

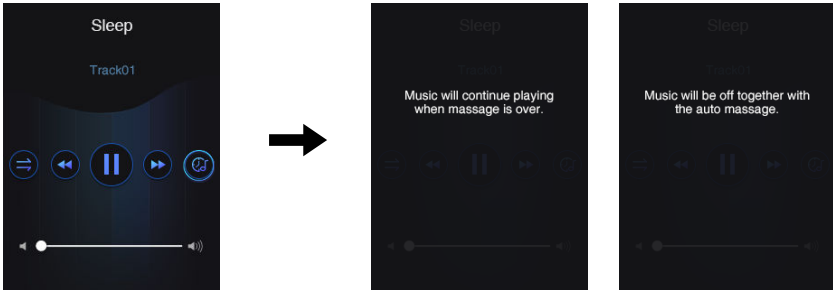

Heating

Select this icon and press  to start heating function. Press once to activate lumbar heating function. Press again to activate calf heating function. Press again to cease heating function.

Foot roller







Select this icon and press  to start foot roller function. Press again to cease foot roller function.

LED

Select this icon and press  to turn on the LED light on the speaker. Press again to turn it off.

How to Use

Settings

1. Press  to select the item user want to set.
2. Press  to select the setting user prefer.
3. Language: English / 简体中文
4. Icon volume:  to turn up;  to turn down.
5. Screen sleep: Never/1minute/5 minutes/10 minutes/15 minutes
6. Screen brightness:  to turn up;  to turn down.

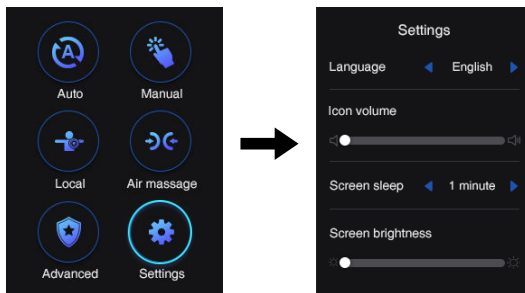

Cleaning and maintenance

1. Cleaning of the synthetic leather

Wipe the synthetic leather with a soft dry cloth.

- Do not clean the product with chemicals such as thinners, gasoline and alcohol.
- When using a leather maintenance product (cleaning cloth) sold on the market, follow its directions for use.
- If the synthetic leather is very dirty, wipe it with the method below.

- ① Put a piece of soft cloth into water or 3% to 5% neutral detergent contained hot water and wring it out.
- ② Wipe surface of the synthetic leather with the soft cloth.
- ③ Wipe the detergent with a piece of cloth once soaked in clean water and wrung out.
- ④ Wipe with a piece of wrung soft cloth.
- ⑤ Have the synthetic leather take natural air drying.

- If it is difficult to remove the stains on the synthetic leather, soak a piece of melamine foam bought from the market into a neutral detergent and use it wipe the product.
- Do not dry the surface by a hair drier.
- Surface of the synthetic leather may be dyed by fabric colors; therefore, be careful when wiping the product with denim or colored cloth.
- Synthetic leather may discolor, so the position in contact with the hair dye used should be covered by a towel.

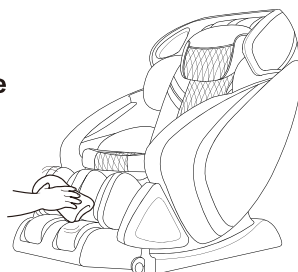
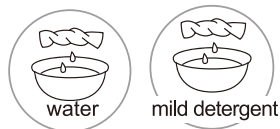

2. Cleaning of the plastic parts

- 1) Put a piece of soft cloth into water or neutral detergent contained hot water, wring it out and wipe the plastic parts.
- Do not clean the product with chemicals such as thinners, gasoline and alcohol.
- 2) Wipe with a piece of cloth once soaked in clean water and wrung out.
- Wring the cloth out before using it to wipe the remote controller.
- 3) Have the plastic parts take natural air drying.

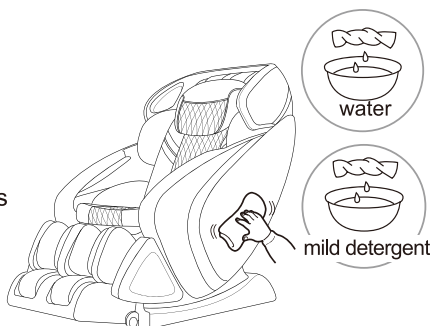

Troubleshooting

This page summarizes the most common problems you could encounter with the product. If you are unable to solve the problem with the information below, contact service center immediately.

If the problem encountered is not listed, please try the following suggestions:

1. Turn off the product and unplug it.
2. Wait for 60 minutes.
3. Plug the product back to the recommended outlet and restart.
4. If the problem persists, contact the authorized service center.

Problem	Possible Cause	Suggestion
The product does not work	The product is not plugged in properly.	Ensure the voltage on the product corresponds to the local mains voltage and then plug in again. Make sure the outlet is properly working.
The product stopped working	The product has just finished its auto timer session and has automatically switched to standby mode.	If you want another session, press the Power button again.
The product stopped working	You may have used the product continuously for 45 minutes where the over heat protection has been activated.	Unplug the product and let it cool down for 60 minutes before you use it again.
The product does not work	An excessive load has been applied on the product.	Reduce the excessive load and start again.
The product is abnormally warm	The product is likely to be overused.	Unplug the product and let it cool down before using it again.
Noise can be heard from the product	Noise is made by the mechanical parts of the product.	This is normal and does not mean that the product is faulty.

Grounding Instructions

This product must be grounded. If it should malfunction or break down, grounding provides a path of least resistance for the electric current to reduce the risk of electric shock. This product is equipped with a cord with an equipment-grounding conductor and a grounding plug. The plug must be plugged into an appropriate outlet that is properly installed and grounded in accordance with all local codes and ordinances.

Danger-Improper connection of the equipment-grounding conductor can result in a risk of electric shock. Check with a qualified electrician or service technician if the product will not fit the outlet, have a proper outlet installed by a qualified electrician.

This product is for use on a nominal 120V circuit and has grounding plug that looks like that plug illustrated below. Make sure that the product is connected to an outlet having the same configuration as the plug. No adapter should be used with this product.

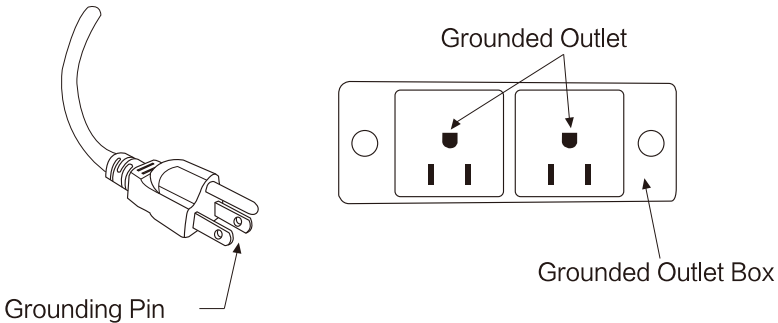

Chair Specifications

Description	Specifications
Model No.	Osaki Pro Admiral
Rated Voltage	110-120V~
Rated Frequency	60Hz
Rated Power Consumption	110W
Rated Time	15 minutes
Dimensions(L x W x H)	Upright: 64.2" x 30.7" x 50.0"
	Reclined: 74.8" x 30.7" x 40.6"
Weight	Gross Weight: Approx. 284lbs
	Net Weight: Approx. 239 lbs
Length of Wire	Controller wire: 59.0"
	Power supply wire: 70.9"
Usage Condition	Environment temperature: 32°F~95°F
	Contrasting humidity: 20-80RH
Storage Condition	Storage temperature: 23°F~95°F
	Storage humidity: 20-80RH
Safety Feature	Equipped with overheated and power
Maximum body weight of user	220 lbs

Issue : 2019.03
V1.0